



伟达电梯有限公司
WELLIFT ELEVATOR CO., LTD.

观光电梯 | V8-0

OBSERVATION
ELEVATOR





伟达的观光电梯是将V8客梯的轿厢形状加以改变而来，具备客梯的所有先进功能。在安装位置上分为室外封闭型和室内开放型两种。在布置方案上我们也可以做无机房的设计，所以适用于新建筑的井道，也可以配合老建筑的原有井道或改造井道。

观光电梯轿厢的形状可以根据建筑物的外观而选配，通常有方形、菱形、圆形等，我们也可以根据大厦业主个性化的要求而作特别设计。

WT observation elevator is transformed from V8 elevator by changing their car shape while preserving the complete advanced functions. The installation type can be outdoor close type or indoor open type depending on mounted site. Machine roomless design is available when arrangement planning, so that it is applicable for both new-type well in new building and old-type well or reconstructed well in old building.

The car shape of observation elevator can be selected depending on the appearance of the building, the common shapes are rectangle, diamond, circular, etc., special shape for showing individuality is available on customer's request.

标准规格 Standard specification

伟达目前可供的观光电梯标准规格

载重(kg) | 750, 1000, 1150, 1350, 1600

速度(m/s) | 1.0, 1.5, 1.75, 2.0

The available standards specification of observation elevators are as following

Load(kg) | 750, 1000, 1150, 1350, 1600

Speed(m/s) | 1.0, 1.5, 1.75, 2.0

伟达观点 WELLIFT'S Viewpoint

观光电梯是一种非标准化的产品，是建筑物个性的独特点缀。伟达决不会为不同的工程安装上完全一样的观光电梯。量身定制、营造个性独特的完美建筑是我们共同的理想和责任。

Observation elevator is a non-standard product, it is the expression of building individuality. WELLIFT would not install the same observation elevator for different projects. Making perfect unique-individuality buildings is our ideal and responsibility.



可选配全透明的厅轿门
Optional transparent car door

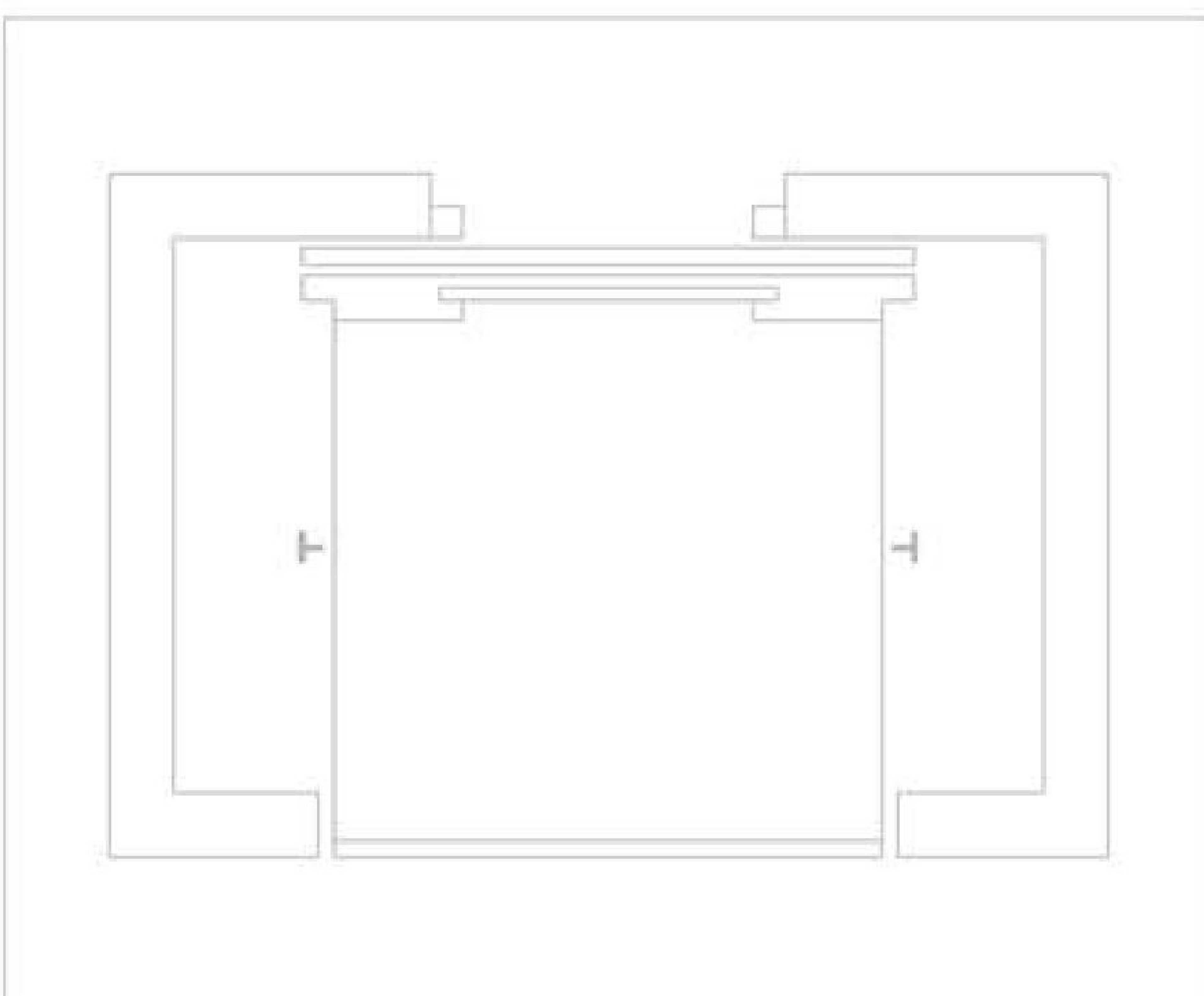

系列型号	V8或V8-M
载重(kg)	750 , 1000, 1150, 1350, 1600
速度(m/s)	1.0, 1.5, 1.75, 2.0
驱动技术	有齿轮或永磁同步无齿轮
布置方式	有机房或无机房
非上述规格请洽本公司销售部	

Models: V8 or V8-M
Load(kg): 750 , 1000, 1150, 1350, 1600
Speed(m/s): 1.0, 1.5, 1.75, 2.0
Drive technology: Gear or permanent magnet synchronous gearless motor
Arrange mode: With machine room or roomless
 If you need any specification beyond listed, please contact our sales department.

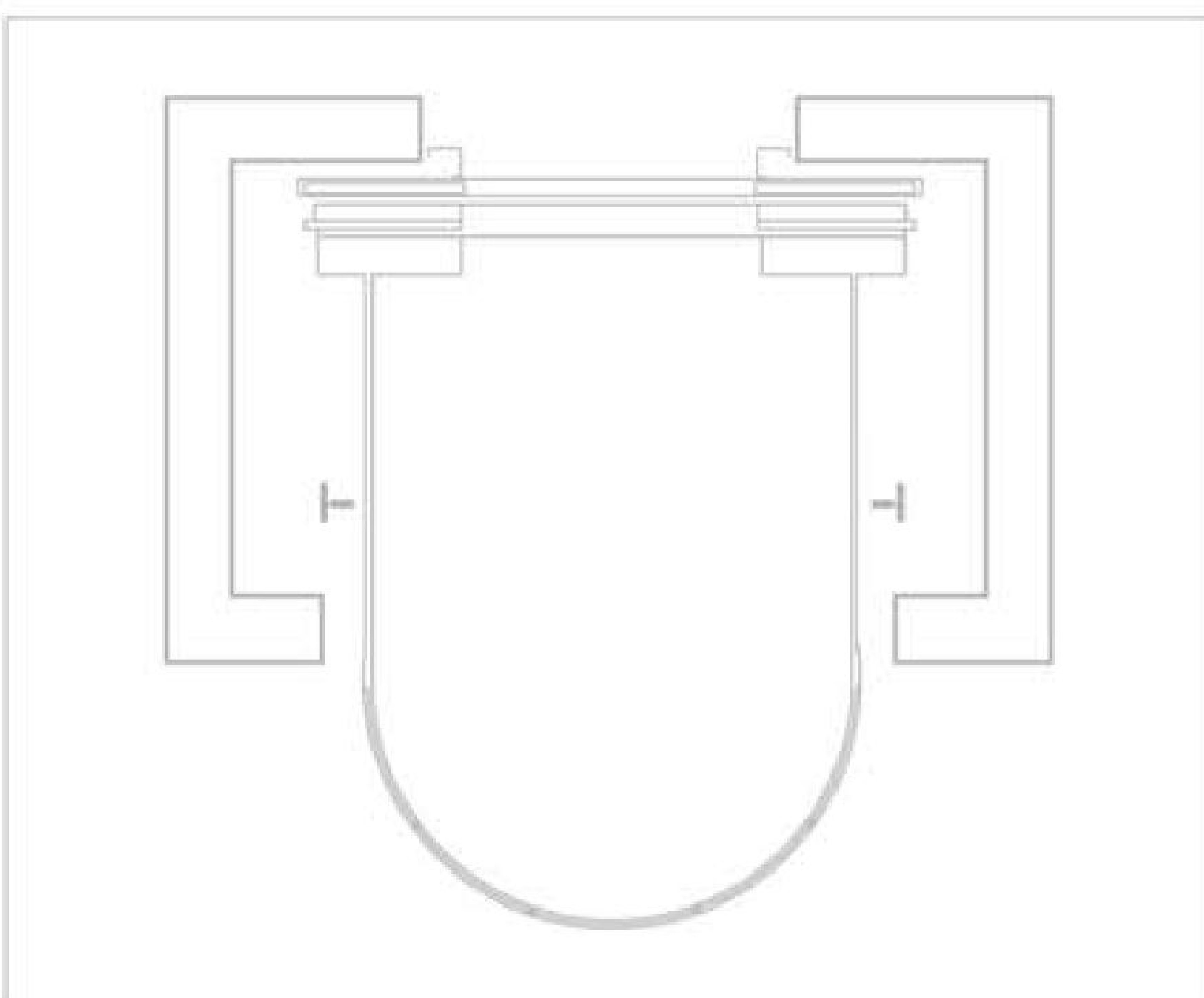
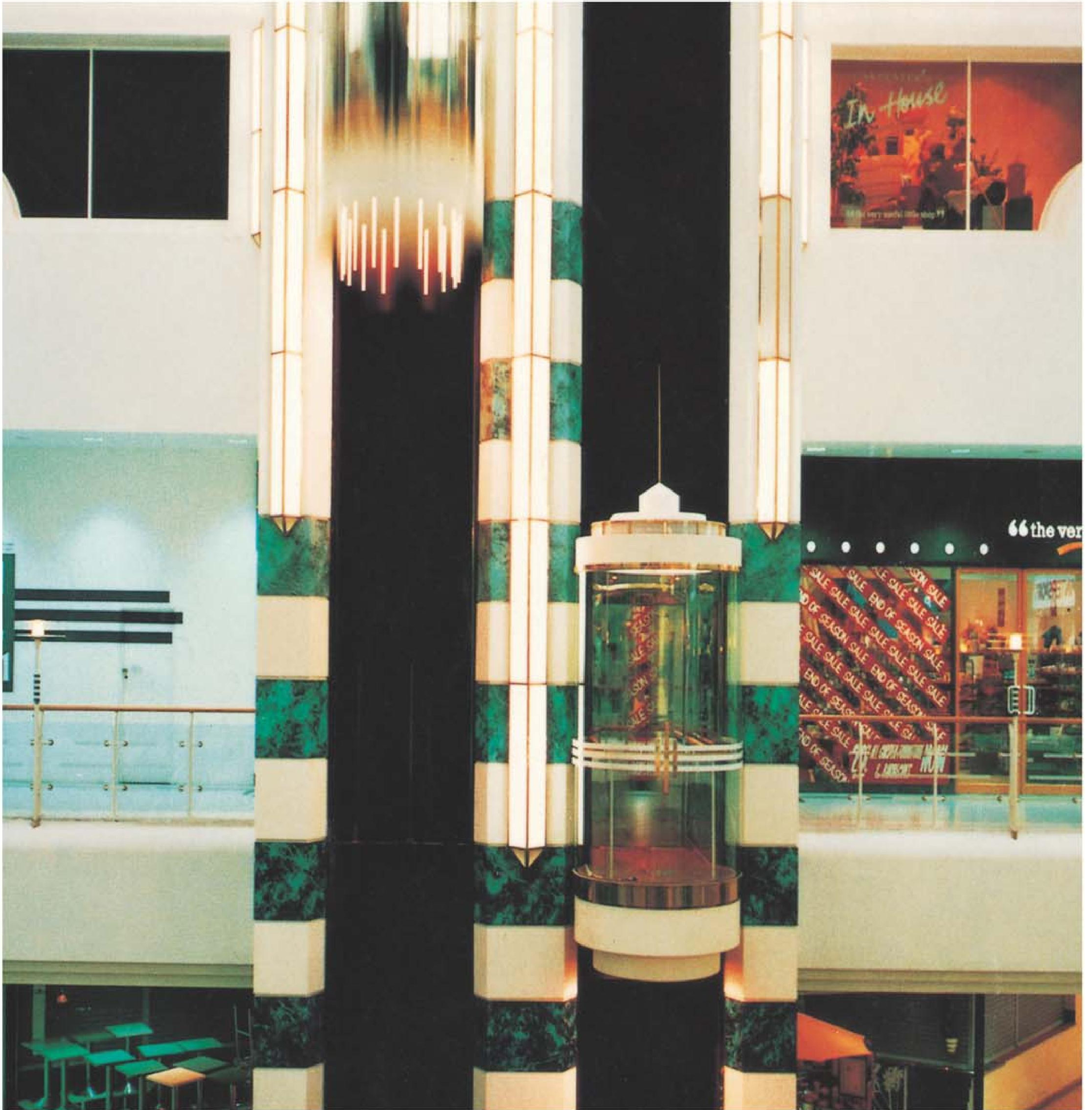

系列型号	V8或V8-M
载重(kg)	750 , 1000, 1150, 1350, 1600
速度(m/s)	1.0, 1.5, 1.75, 2.0
驱动技术	有齿轮或永磁同步无齿轮
布置方式	有机房或无机房
非上述规格请咨询洽本公司销售部	

Models: V8 or V8-M

Load(kg): 750 , 1000, 1150, 1350, 1600

Speed(m/s): 1.0, 1.5, 1.75, 2.0

Drive technology: Gear or permanent magnet synchronous gearless motor

Arrange mode: With machine room or roomless

If you need any specification beyond listed, please contact our sales department.

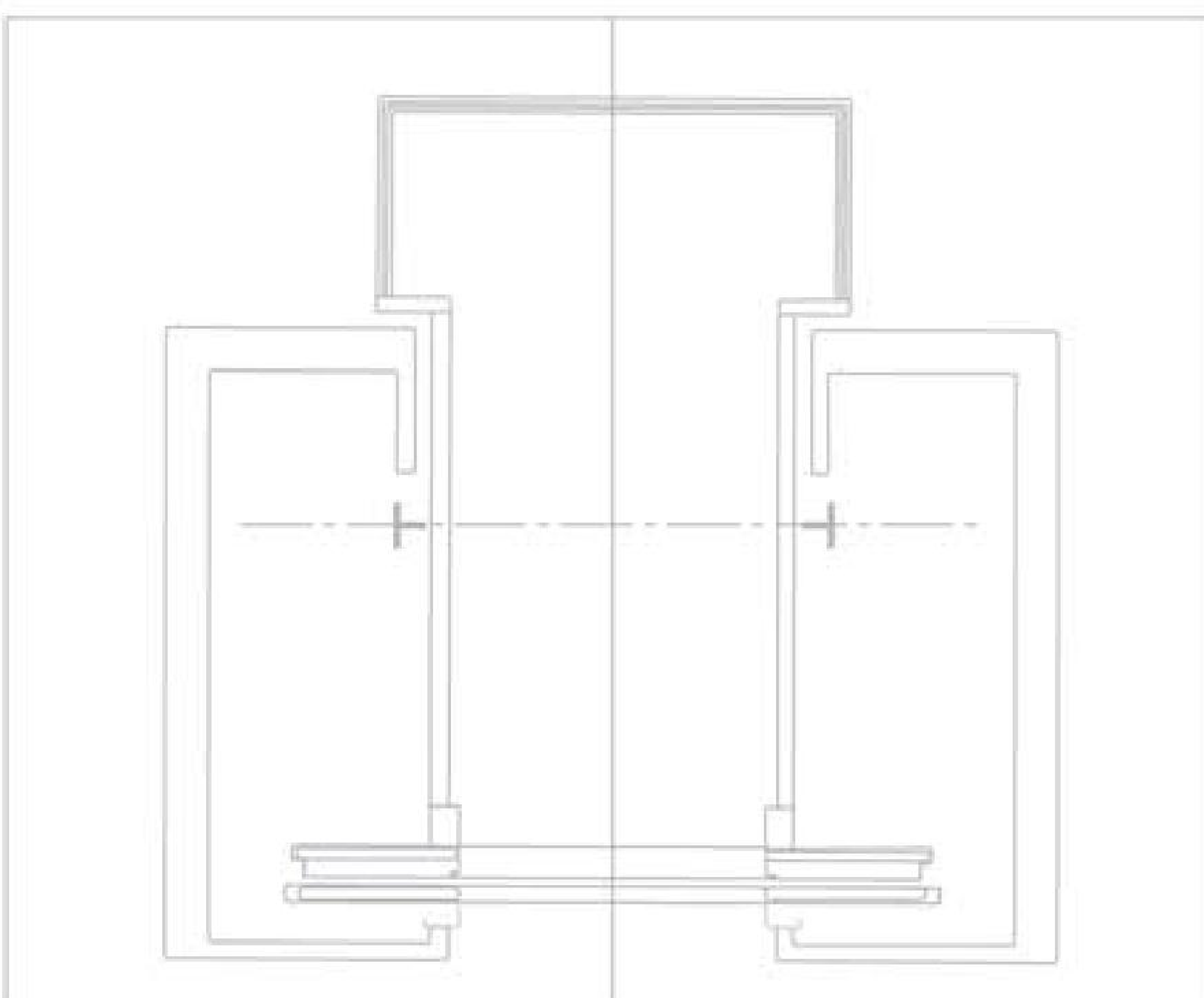

系列型号	V8或V8-M
载重(kg)	750 , 1000, 1150, 1350, 1600
速度(m/s)	1.0, 1.5, 1.75, 2.0
驱动技术	有齿轮或永磁同步无齿轮
布置方式	有机房或无机房
非上述规格请洽本公司销售部	

Models: V8 or V8-M

Load(kg): 750 , 1000, 1150, 1350, 1600

Speed(m/s): 1.0, 1.5, 1.75, 2.0

Drive technology: Gear or permanent magnet synchronous gearless motor

Arrange mode: With machine room or roomless

If you need any specification beyond listed, please contact our sales department.

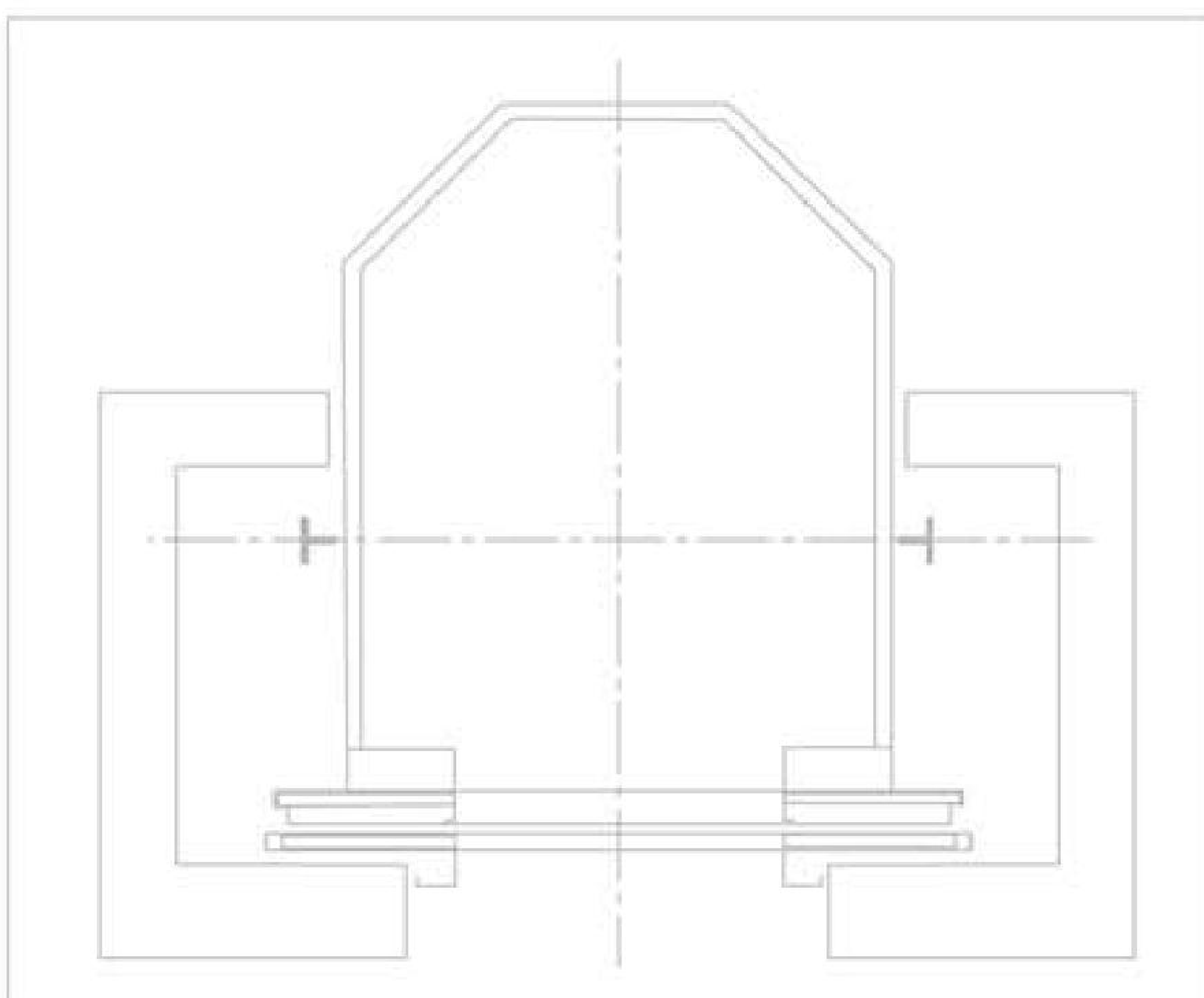

系列型号	V8或V8-M
载重(kg)	750 , 1000, 1150, 1350, 1600
速度(m/s)	1.0, 1.5, 1.75, 2.0
驱动技术	有齿轮或永磁同步无齿轮
布置方式	有机房或无机房
非上述规格请咨询洽本公司销售部	

Models: V8 or V8-M
Load(kg): 750 , 1000, 1150, 1350, 1600
Speed(m/s): 1.0, 1.5, 1.75, 2.0
Drive technology: Gear or permanent magnet synchronous gearless motor
Arrange mode: With machine room or roomless
 If you need any specification beyond listed, please contact our sales department.



半圆形有机房观光电梯尺寸

Machine Room Panoramic Elevator with Semi-Circular type

载重 Capacity	速度 Speed	开门尺寸 Entrance	轿厢内尺寸 (宽 X 深 X 高) Car inside dimension			井道尺寸 Hoistway internal dimension				机房尺寸 (宽 X 深 X 高) Machine room dimension		
			JJ X HH (mm)	AA (mm)	BB (mm)	CH (mm)	AH (mm)	BH (mm)	OH (mm)	PD (mm)	X (mm)	Y (mm)
630	1.0	800 X 2100	1000	1695	2400	2050	2220	4300	1800	2050	2800	2300
	1.6							4450	1900			
	1.75							4550	2000			
800	1.0	800 X 2100	1200	1708	2400	2150	2220	4300	1800	2150	2800	2300
	1.6							4450	1900			
	1.75							4550	2000			
	2.0							4800	2200			
1000	1.0	900 X 2100	1300	1908	2400	2250	2420	4300	1800	2250	3000	2300
	1.6							4450	1900			
	1.75							4550	2000			
	2.0							4800	2200			

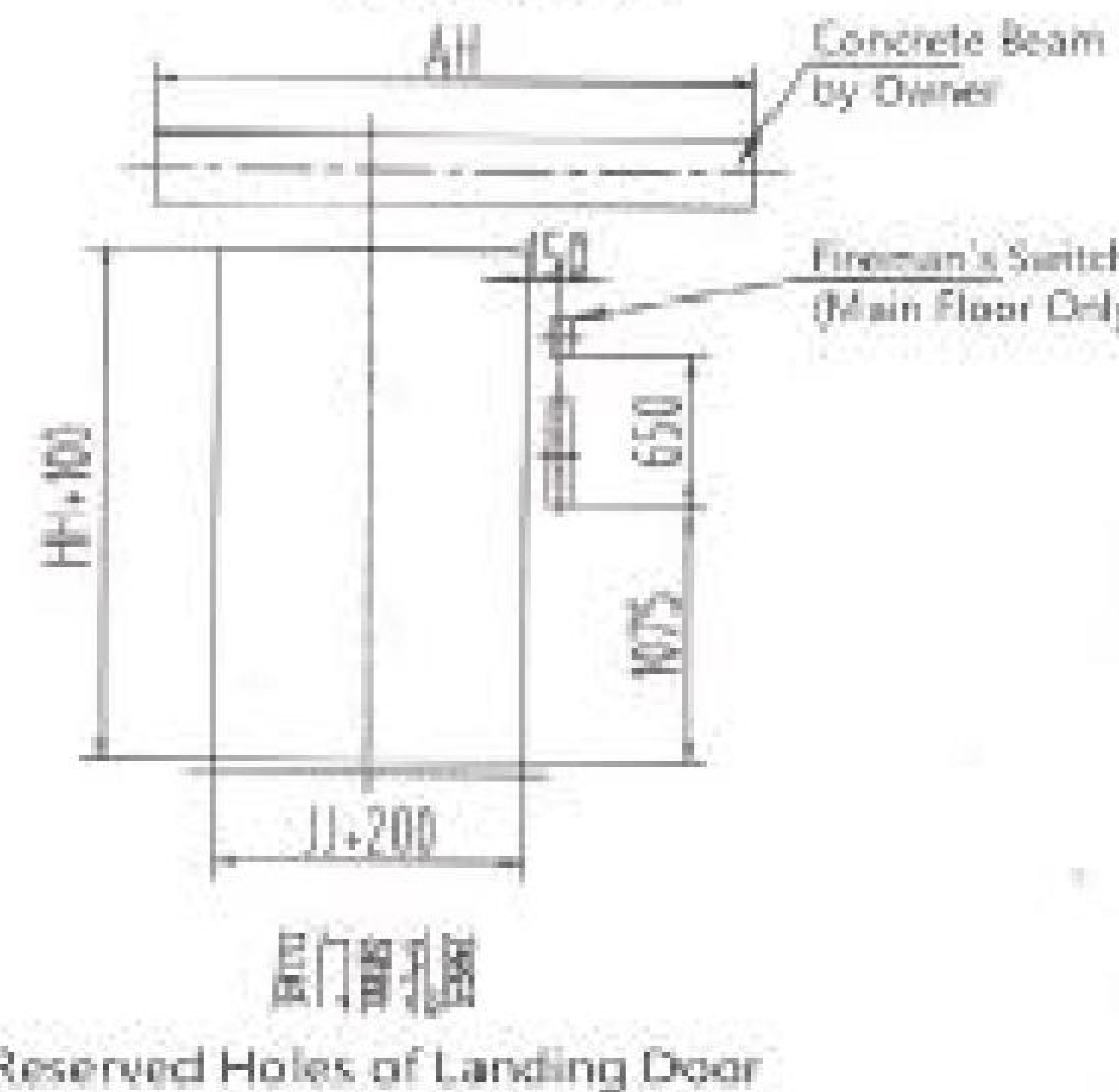
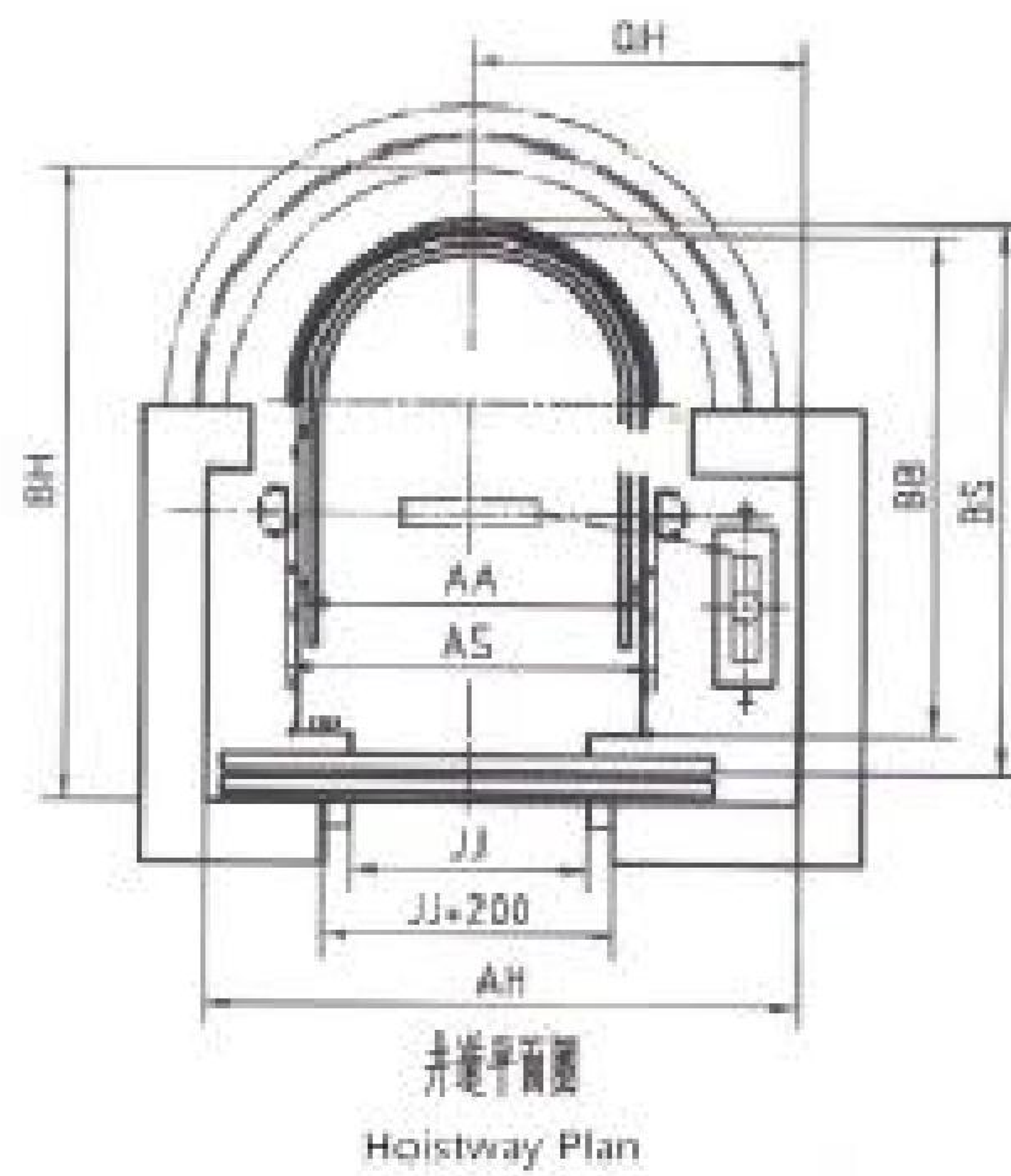
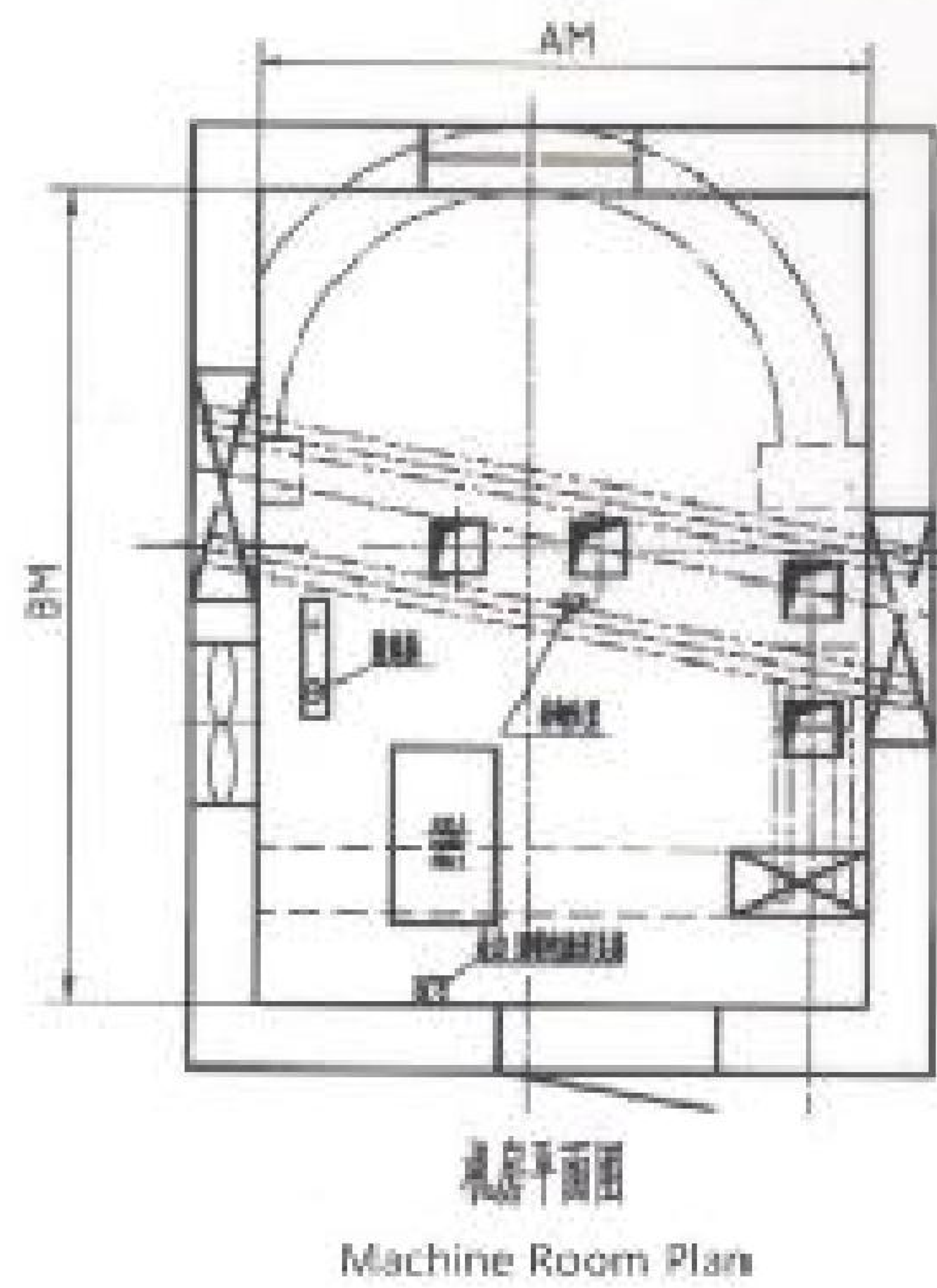
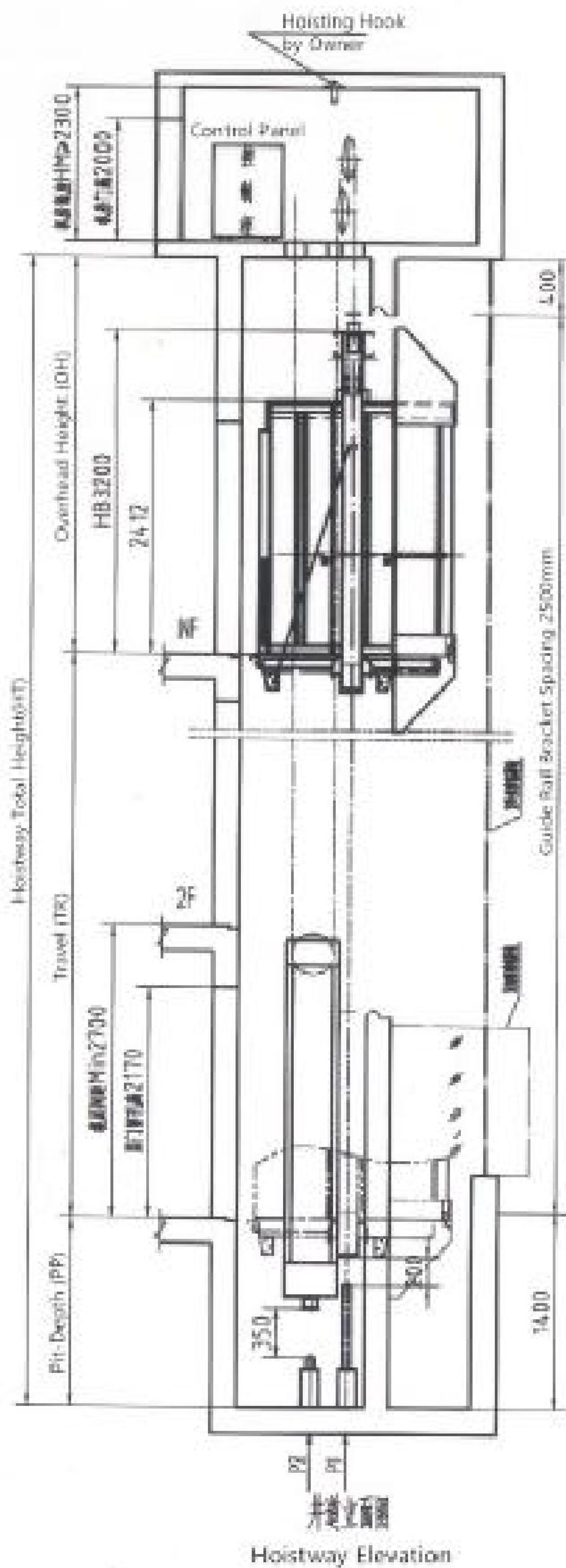

菱形有机房观光电梯尺寸

Machine Room Panoramic Elevator with Cutting-angle type

载重 Capacity	速度 Speed	开门尺寸 Entrance	轿厢内尺寸 (宽 X 深 X 高) Car inside dimension			井道尺寸 Hoistway internal dimension				机房尺寸 (宽 X 深 X 高) Machine room dimension		
(kg)	(m/s)	JJ X HH (mm)	AA (mm)	BB (mm)	CH (mm)	AH (mm)	BH (mm)	OH (mm)	PD (mm)	X (mm)	Y (mm)	H (mm)
630	1.0	800 X 2100	1014	1708	2400	2050	2220	4300	1800	2050	2800	2300
	1.6							4450	1900			
	1.75							4550	2000			
800	1.0	800 X 2100	1244	1708	2400	2150	2220	4300	1800	2150	2800	2300
	1.6							4450	1900			
	1.75							4550	2000			
	2.0							4800	2200			
1000	1.0	900 X 2100	1344	1908	2400	2250	2420	4300	1800	2250	3000	2300
	1.6							4450	1900			
	1.75							4550	2000			
	2.0							4800	2200			

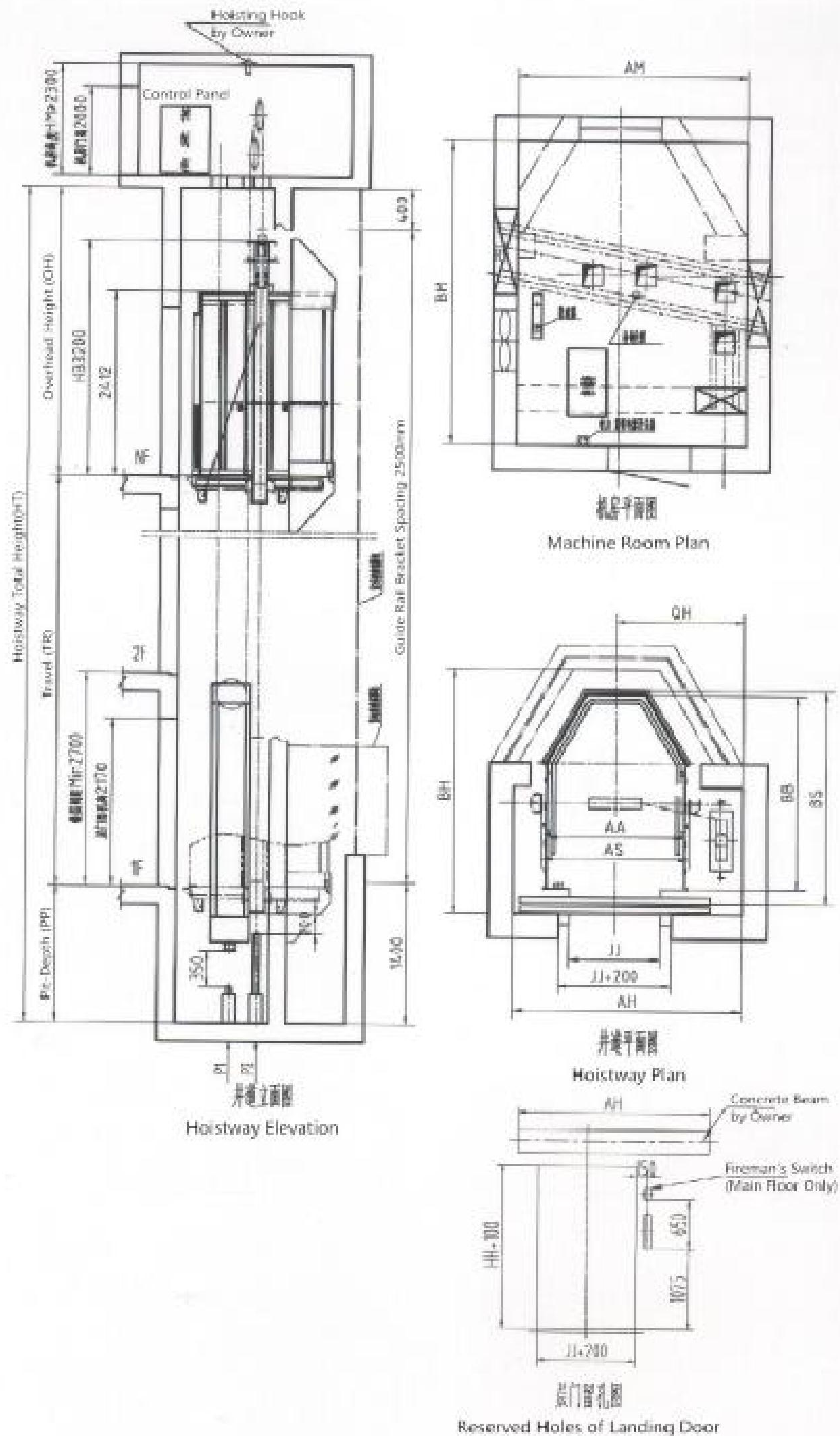

半圆形无机房观光电梯尺寸

Machine Roomless Panoramic Elevator with Semi-Circular type

载重 Capacity	速度 Speed	开门尺寸 Entrance	轿厢内尺寸 (宽 X 深 X 高) Car inside dimension			井道尺寸 Hoistway internal dimension			
(kg)	(m/s)	JJ X HH (mm)	AA (mm)	BB (mm)	CH (mm)	AH (mm)	BH (mm)	OH (mm)	PD (mm)
630	1.0	800 X 2100	1000	1695	2385	2250	2220	4500	1800
	1.6							4650	1900
	1.75							4700	1950
800	1.0	800 X 2100	1200	1708	2385	2400	2220	4500	1800
	1.6							4650	1900
	1.75							4700	1950
1000	1.0	900 X 2100	1300	1908	2385	2500	2450	4500	1800
	1.6							4650	1900
	1.75							4700	1950

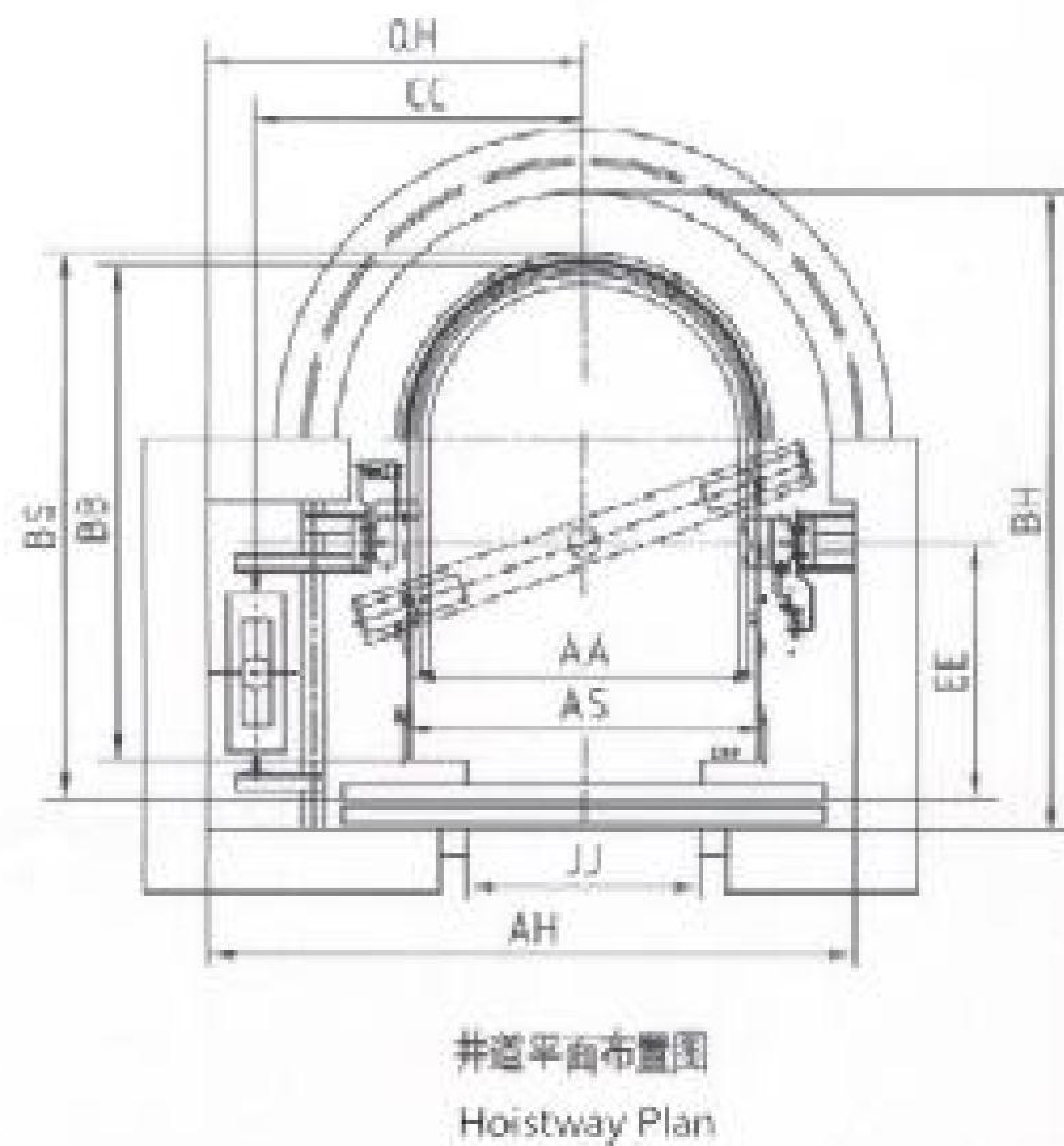
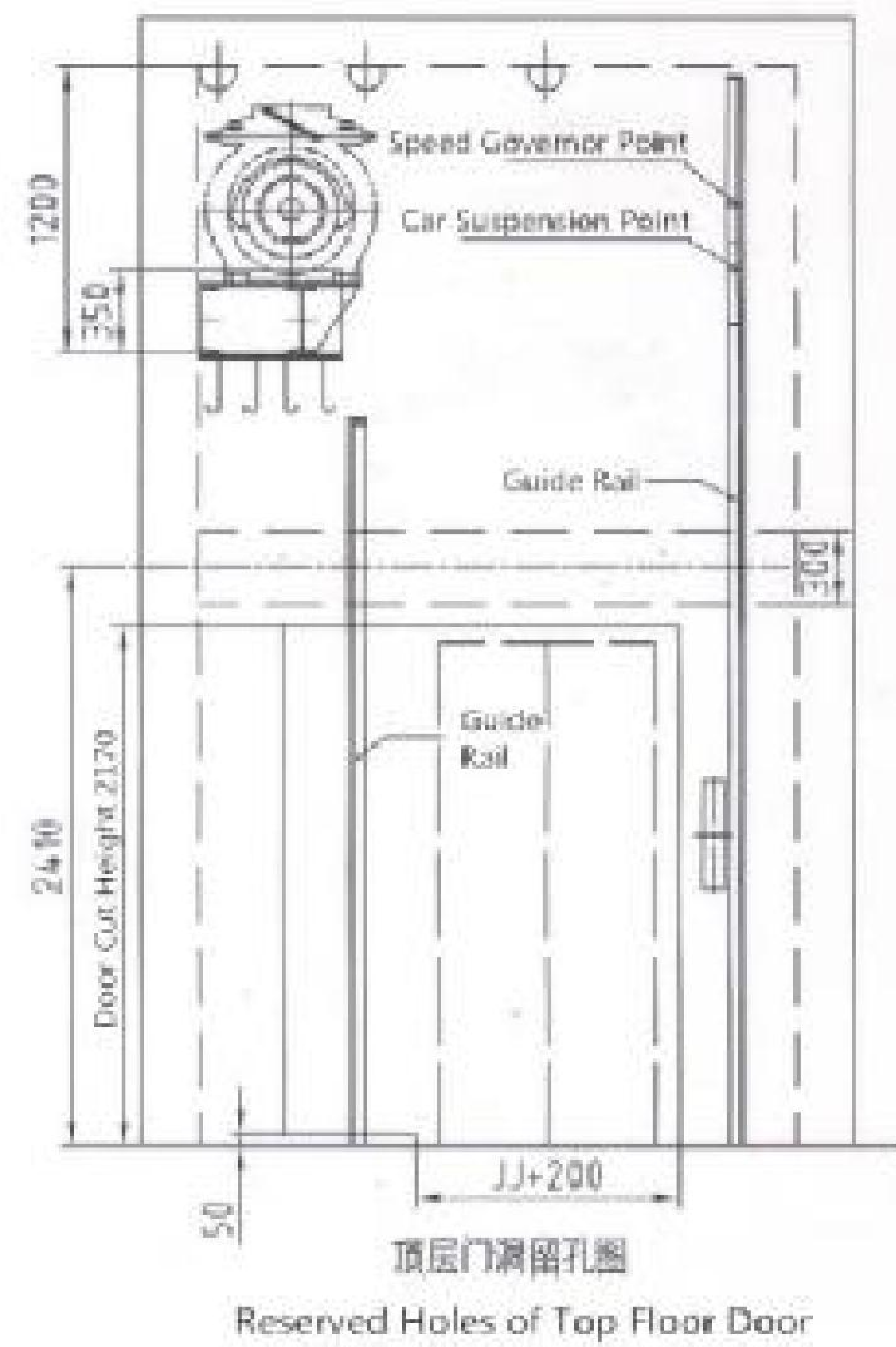
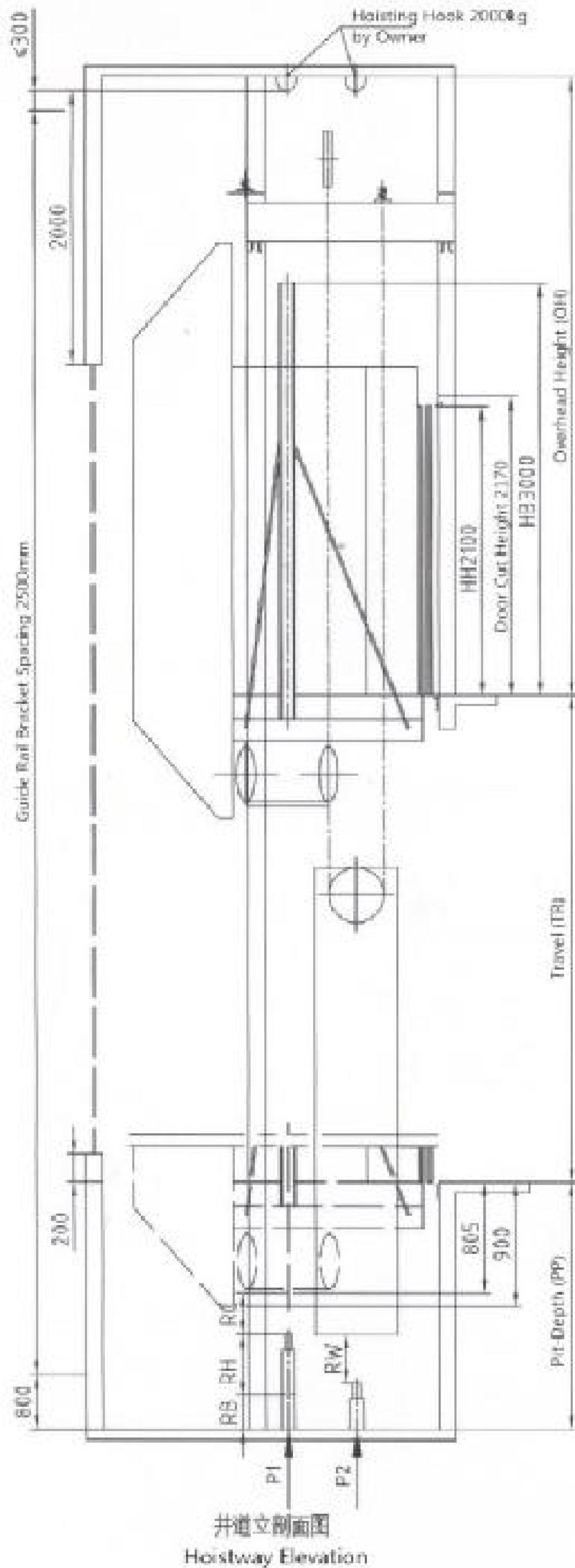

菱形无机房观光电梯尺寸

Machine Roomless Panoramic Elevator with Cutting-angle type

载重 Capacity	速度 Speed	开门尺寸 Entrance	轿厢内尺寸 (宽 X 深 X 高) Car inside dimension			井道尺寸 Hoistway internal dimension			
(kg)	(m/s)	JJ X HH (mm)	AA (mm)	BB (mm)	CH (mm)	AH (mm)	BH (mm)	OH (mm)	PD (mm)
630	1.0	800 X 2100	1044	1708	2385	2250	2220	4500	1800
	1.6							4650	1900
	1.75							4700	1950
800	1.0	800 X 2100	1244	1708	2385	2400	2220	4500	1800
	1.6							4650	1900
	1.75							4700	1950
1000	1.0	900 X 2100	1344	1908	2385	2500	2450	4500	1800
	1.6							4650	1900
	1.75							4700	1950

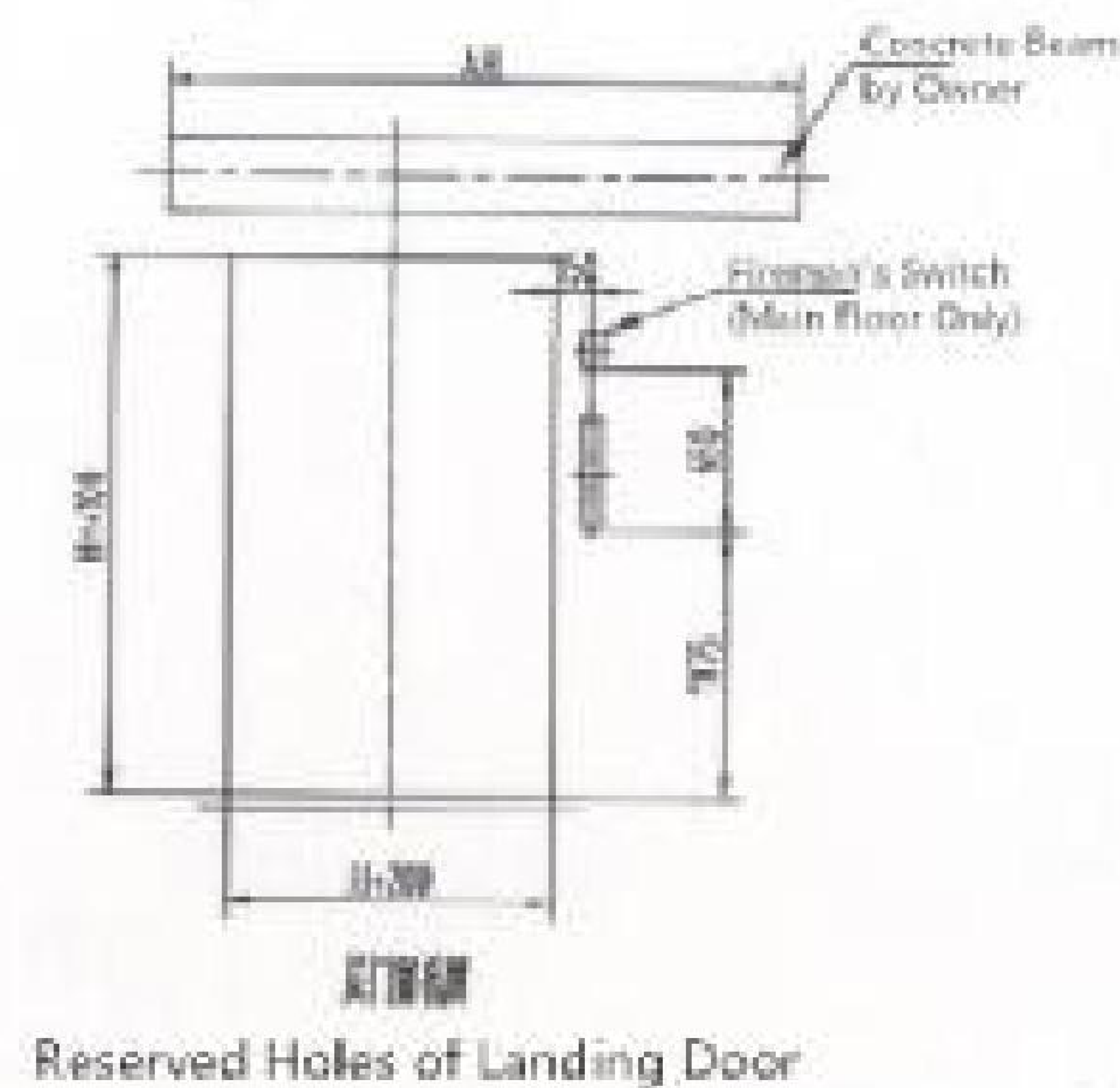
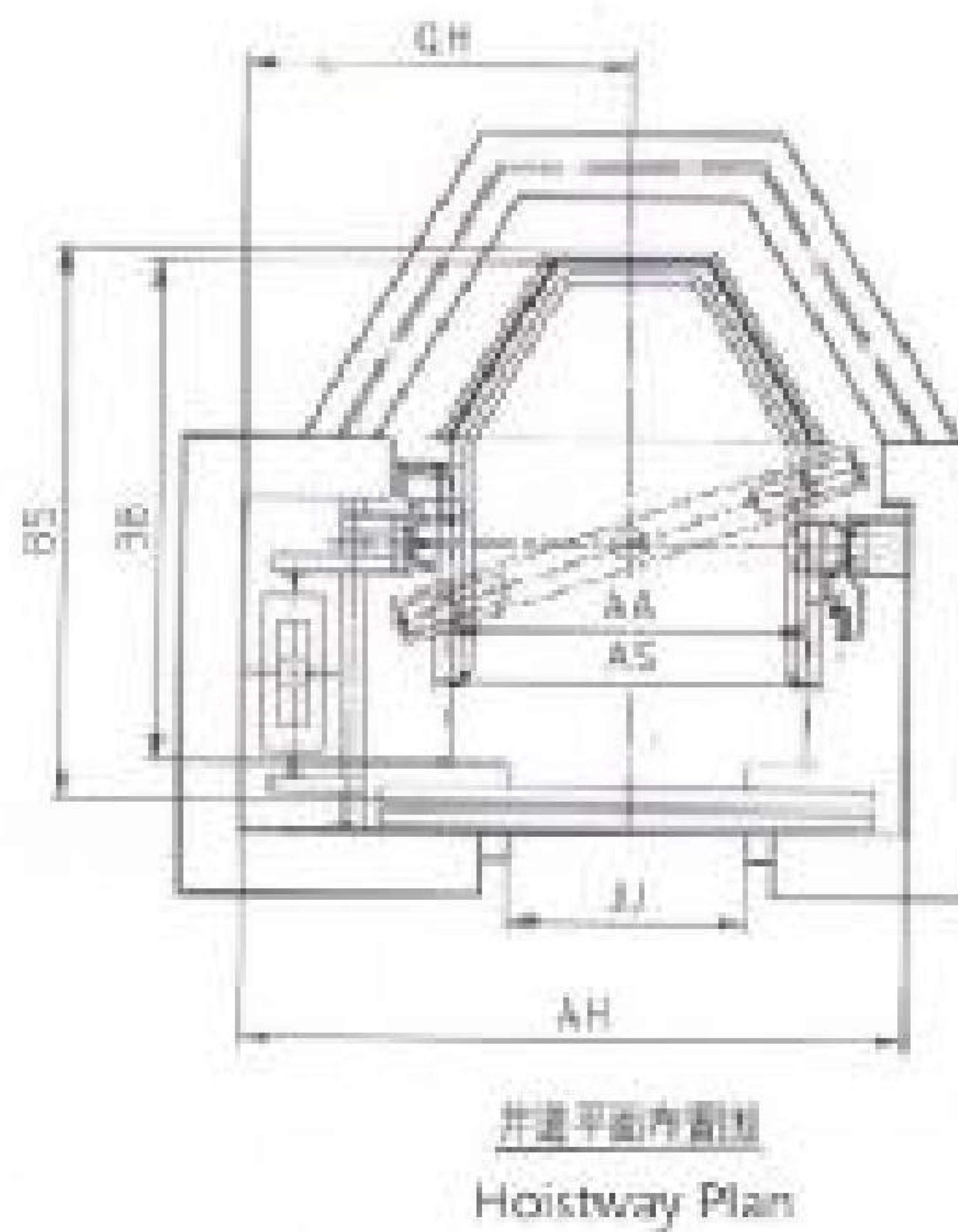
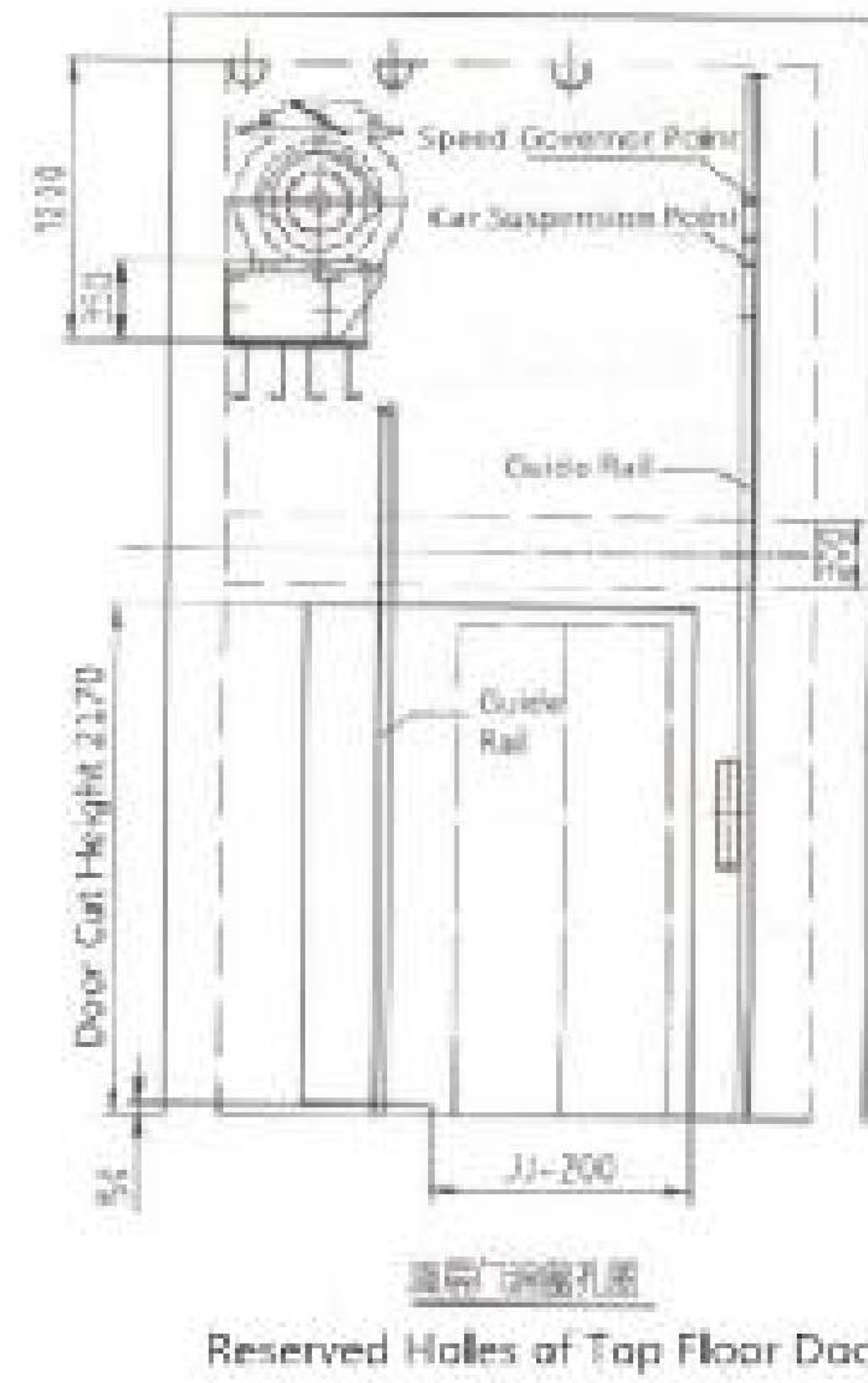
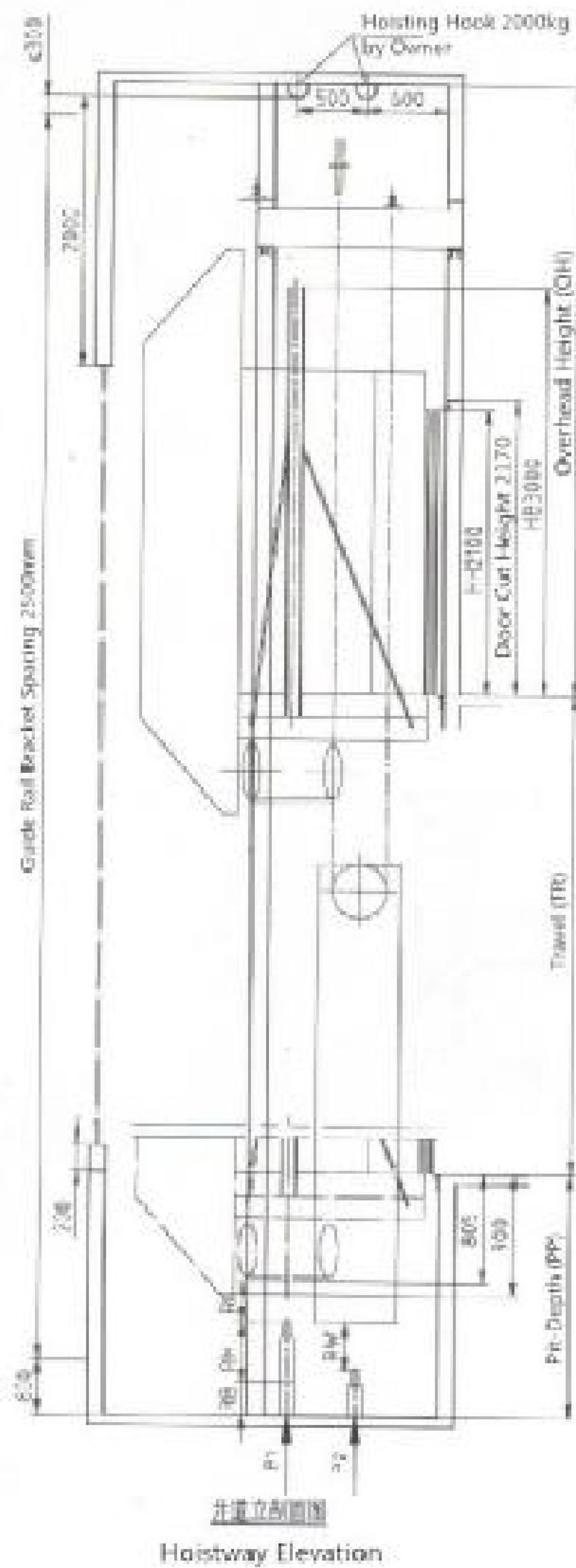



全球市场 | Market



伟达电梯有限公司
WELLIFT ELEVATOR CO.,LTD.

厦门市思明区世茂海峡大厦A栋3503室
Room 3503, Tower A, Shimao Strait Building, Xiamen, China.
Tel: 0086-592-5166666 Email: info@wellift.com

www.wellift.com